

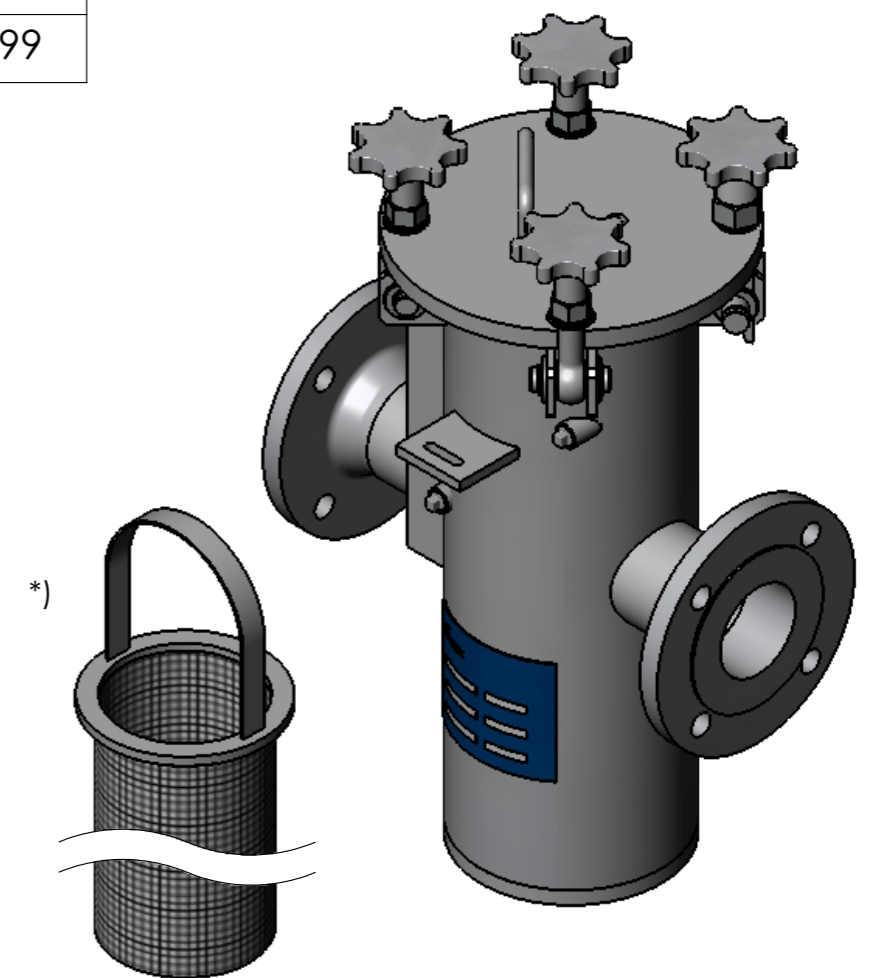

NOZZLE INDEX

Connection	Size	Type	DIN
N1	DN 65 PN16	Inlet	DIN 2633, C
N2	DN 65 PN16	Outlet	DIN 2633, C
N3	Rp 3/8	Vent	DIN 2999
N4	Rp 3/4	Drain	DIN 2999
N5	Rp 1/4	Diff. pressure	DIN 2999
N6	Rp 1/4	Diff. pressure	DIN 2999

SPECIFICATION

Max. pressure	10 bar
Test pressure	14,3 bar
Max. temperatur	-10/+80°C
Volume	11 l
Material housing	AISI 304
Material gasket	O-Ring FPM
Material bolts	stainless steel
Weight	27 kg
* filter basket against filter mesh - optional	



Date	Name	Type	SF-IL-16-10/F65-A2
10.08.2009	Brixius		
03.04.2013	Leekes		
		Article-No.	5201763065
Am Weinkastell 14 55270 Klein-Winternheim		acc. Drawing: 10-1224 Rev.1	