

NOZZLE INDEX

Connection	Size	Type	DIN
N1	DN 80 PN16	Inlet	DIN 2633,C
N2	DN 80 PN16	Outlet	DIN 2633,C
N3	2x Rp 1/4	Vent	DIN 2999
N4	2x Rp 1/4	Manometer	DIN 2999
N5	2x Rp 1/2	Drain	DIN 2999
N6	2x Rp 1/2	Drain	DIN 2999
N7	Rp 1/4	Differential Pressure Measurement	DIN 2999
N8	Rp 1/4	Differential Pressure Measurement	DIN 2999

SPECIFICATION

Max. allow. Pressure	10 bar
Test Pressure	14,3 bar
Max. allow. Temperature	-10/+80°C
Volume	72 l
Material Housing	AISI 304
Material Gasket	O-Ring FPM
Material Screws	Stainless Steel
Weight	110 kg

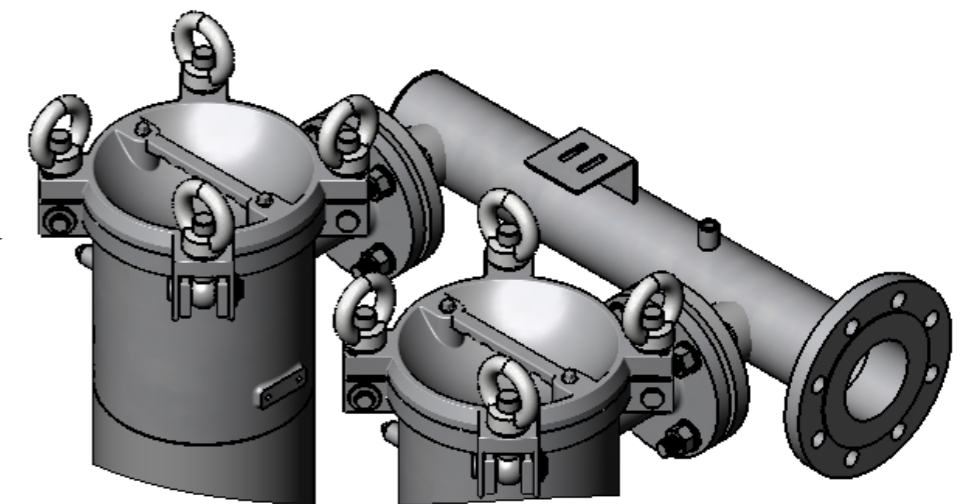
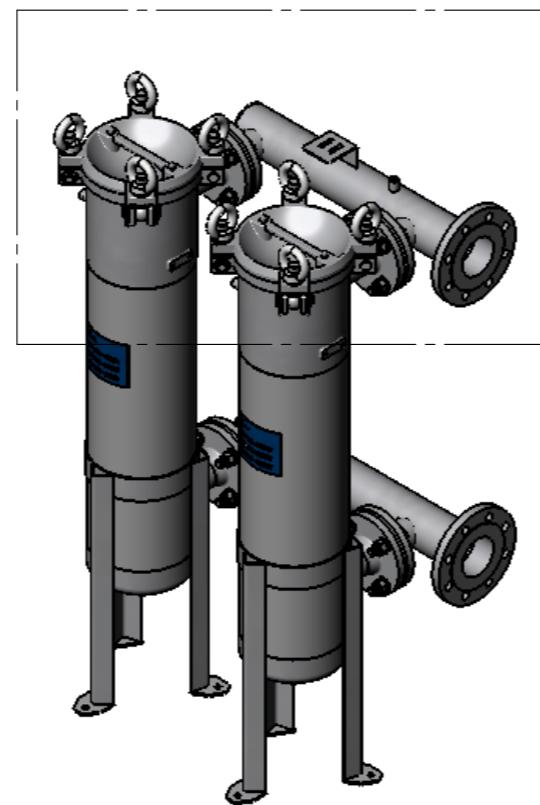
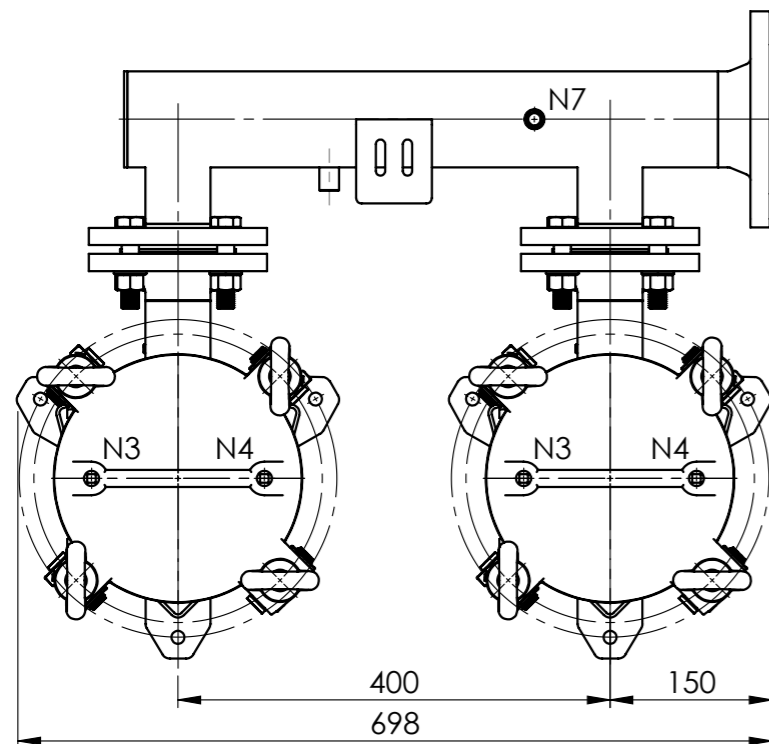

Date	22.01.2013	Name	Leekes	Type	2-BFOS2-OV/F80-A2
				Article-No.	
				Associated Drawing:	10-1346

FUHR GmbH
 Am Weinkastell 14
 55270 Klein-Winternheim