

STUTZEN TABELLE

Anschluss	Größe	Typ	DIN
N1	Rp 1 1/2	Eingang	DIN 2999
N2	Rp 1 1/2	Ausgang	DIN 2999
N3	Rp 1/4	Entlüftung	DIN 2999

SPEZIFIKATION

Max. zul. Druck	20 bar
Prüfdruck	28,6 bar
Max. zul. Temperatur	-10/+90°C
Inhalt	4,5 l
Werkstoff Gehäuse	AISI 316
Werkstoff Dichtung	O-Ring FPM
Werkstoff Schrauben	Edelstahl
Gewicht	7 kg

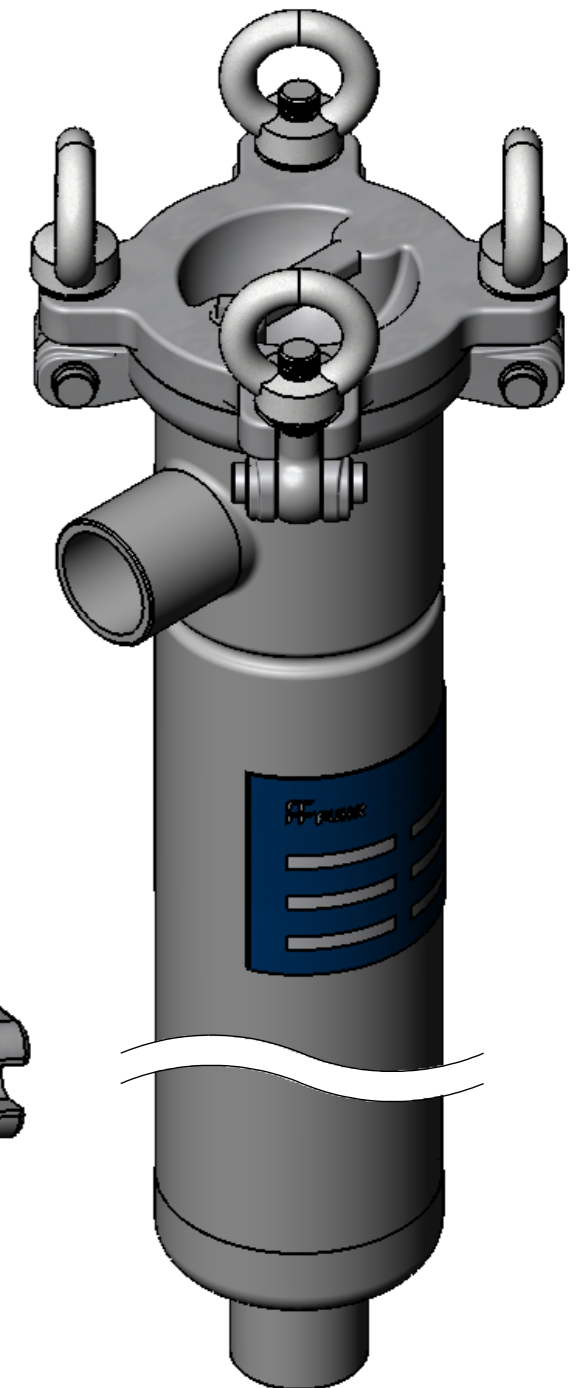
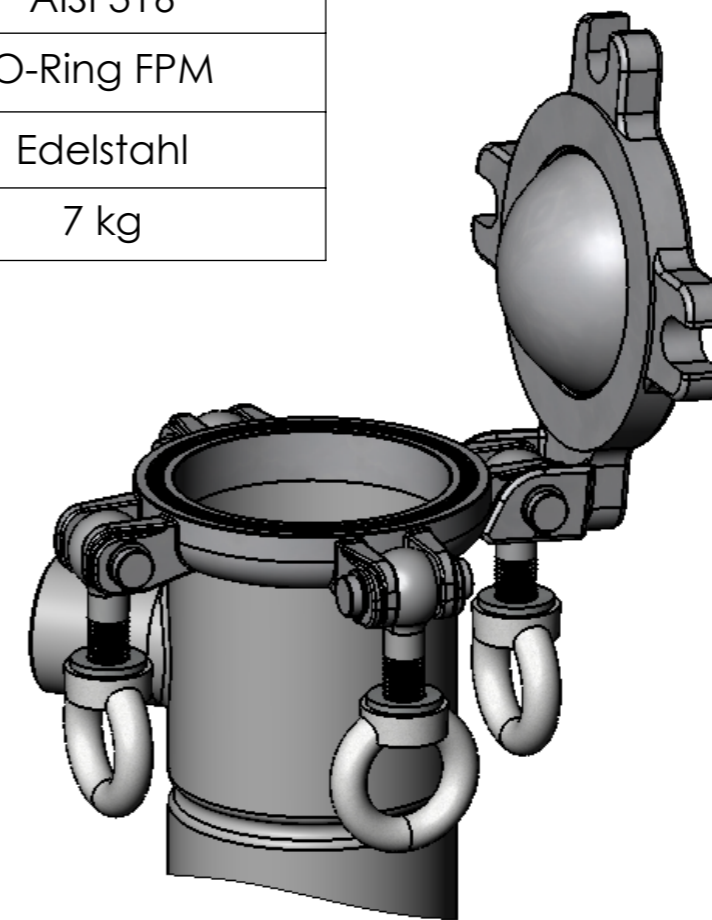

	Datum	Name	Typ	ALSI4-20/G40-B4
	02.04.2015	Neubauer		
Bearb.				
Gepr.				
Norm				
			Artikel-Nr.	5180180400
Am Weinkastell 14 55270 Klein-Winternheim			Zugehörige Zeichnung: 10-1432	Ers.f.: