

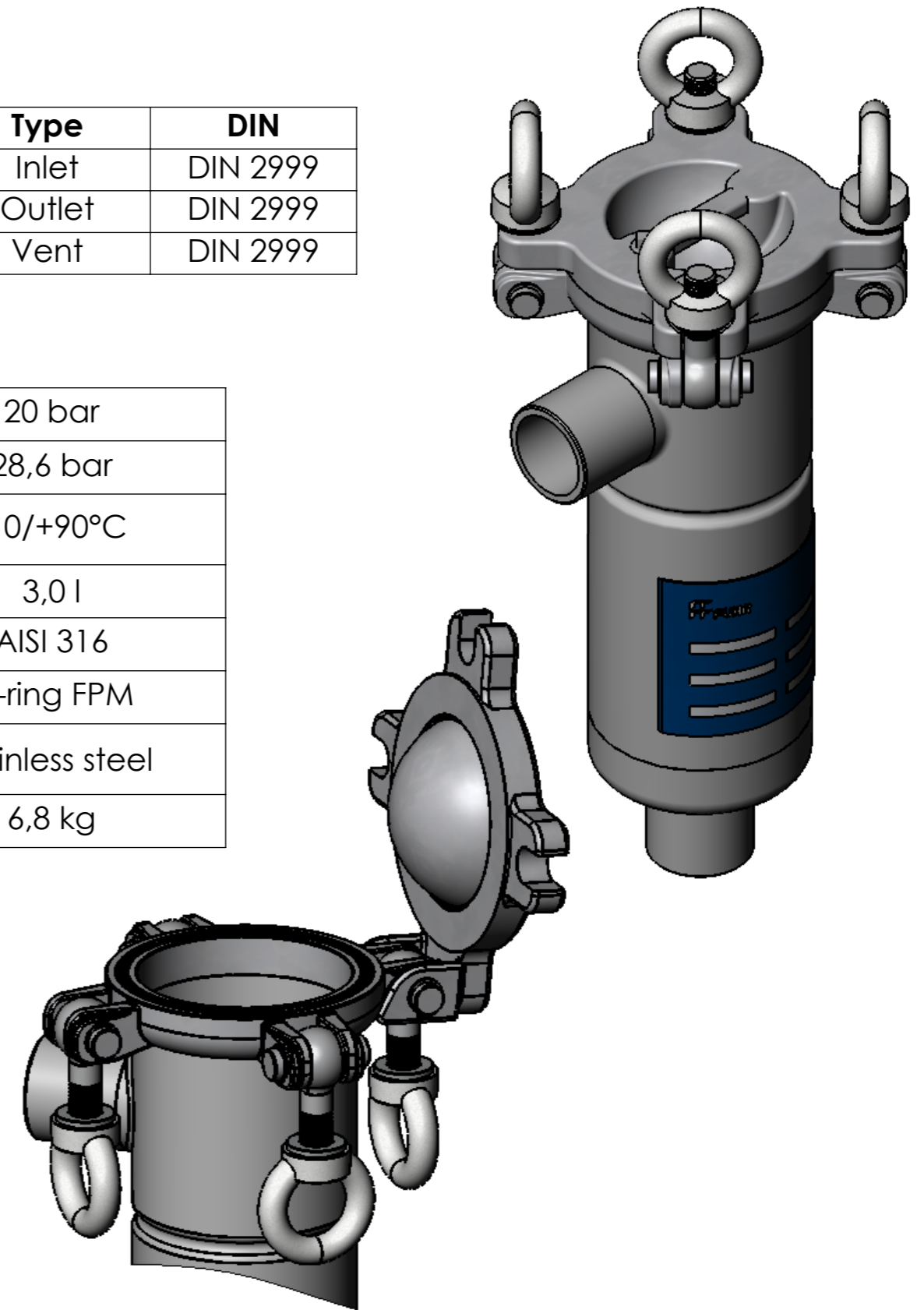

NOZZLE INDEX

Connection	Size	Type	DIN
N1	Rp 1 1/2	Inlet	DIN 2999
N2	Rp 1 1/2	Outlet	DIN 2999
N3	Rp 1/4	Vent	DIN 2999

SPECIFICATION

Max. allow. pressure	20 bar
Test pressure	28,6 bar
Max. allow. temperature	-10/+90°C
Volume	3,0 l
Material housing	AISI 316
Material gasket	O-ring FPM
Material bolts	Stainless steel
Weight	6,8 kg



Date	02.04.2015	Name	Neubauer	Type	ALSI3-20/G40-B4	
Name						
Proof						
Norm						
					Article-No.	5180170400
Am Weinkastell 14 55270 Klein-Winternheim					acc. drawing:	10-1432