

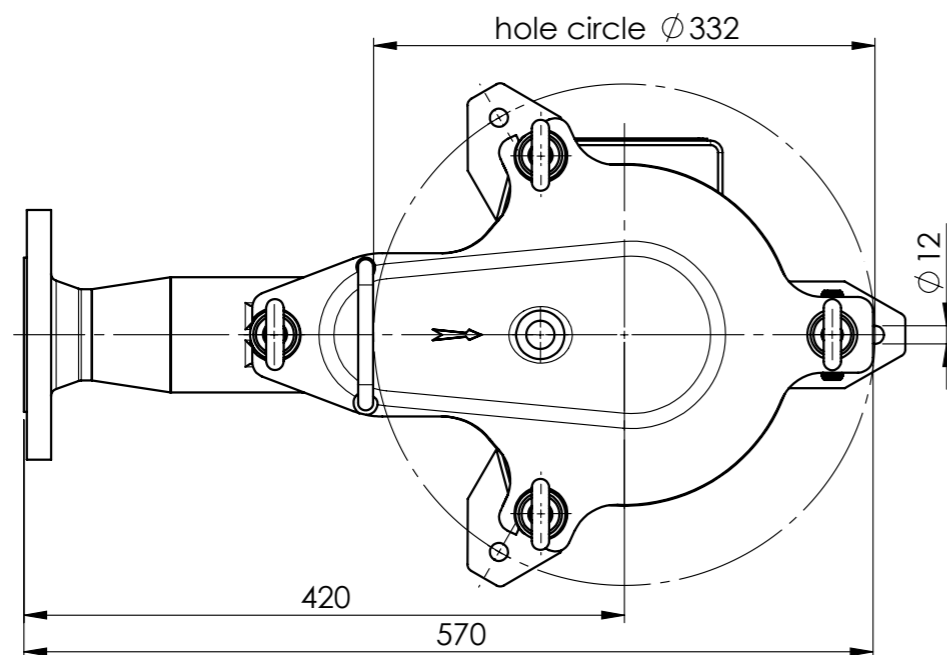
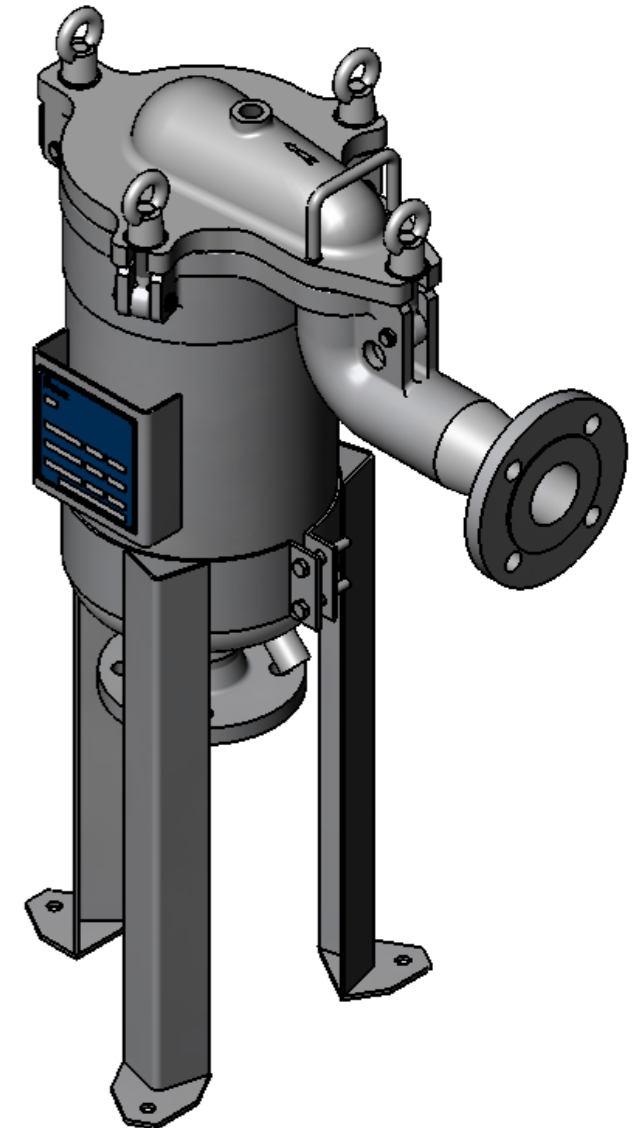

NOZZLE INDEX

Connection	Size	Type	DIN
N1	DN50 PN16	Inlet	DIN 2633, C
N2	DN50 PN16	Outlet	DIN 2633, C
N3	Rp 1/2	Vent	DIN 2999
N4	Rp 1/2	Drain	DIN 2999

SPECIFICATION

Max. perm. Pressure	10 bar
Test Pressure	14,3 bar
Max. perm. Temperature	-10/+80°C
Capacity	18 l
Material Housing	AISI 316
Material Gasket	O-Ring FPM
Material Bolts	Stainless Steel
Weight	37 kg



Date	08.10.2007	Name	Brixius	Type	BFOT1-10/F50
				Article-No.	
 Am Weinkastell 14 55270 Klein-Winternheim				Associated Drawing:	10-1168 Rev.1