

STUTZENPLAN / NOZZEL INDEX

Anschluss / Connection	Größe / Size	Typ / Type	DIN
N1	1 1/2" (DN40 PN16)	Eingang / Inlet	EN1092-1/11B1
N2	1 1/2" (DN40 PN16)	Ausgang / Outlet	EN1092-1/11B1
N3	1" (DN25 PN40)	Entlüftung / Vent	EN1092-1/11B1

SPEZIFIKATION / SPECIFICATION

Anzahl / Art der Filterkerze / Quantity / type of filter cartridge	3 Stk. 226-Bajonett- Adapterfilterkerze (Code 7) 3 pcs. 226-bayonet filter cartridge (Code 7)
Max. zul. Druck (flüssig) / Max. allow. pressure (liquid)	8 bar
Max. zul. Druck (gasförmig) / Max. allow. pressure (gaseous)	-1/+3,5 bar
Max. zul. Temperatur (flüssig) / Max. allow. temperature (liquid)	-10/+90°C
Max. zul. Temperatur (gasförmig) / Max. allow. temperature (gaseous)	-10/+140°C
Inhalt / Volume	~13 l
Werkstoff Gehäuse / Material Housing	1.4404
Werkstoff Dichtung / Material Gasket	FPM
Werkstoff Clampverschluss / Material clamp closure	Edelstahl / stainless steel
Oberfläche innen / Surface quality inside	Ra<0,8 µm
Schweißnähte innen / Welding seams inside	nicht verschliffen / not ground
Oberfläche außen / Surface quality outside	geschliffen / ground
Schweißnähte außen / Welding seams outside	nicht verschliffen / not ground
Gewicht / Weight	~18 kg

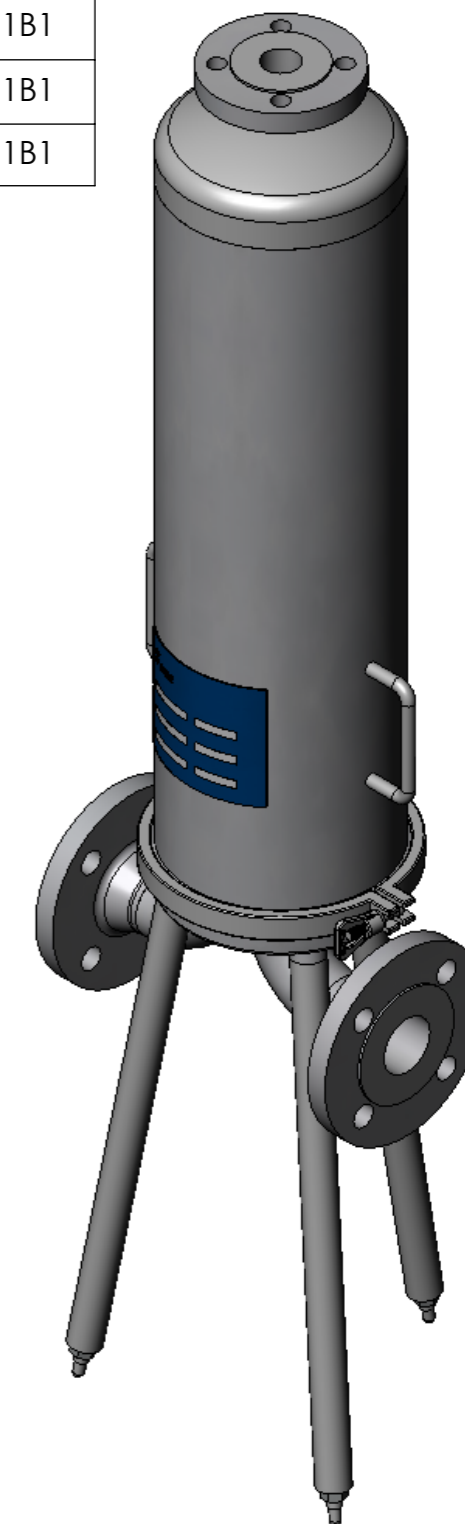
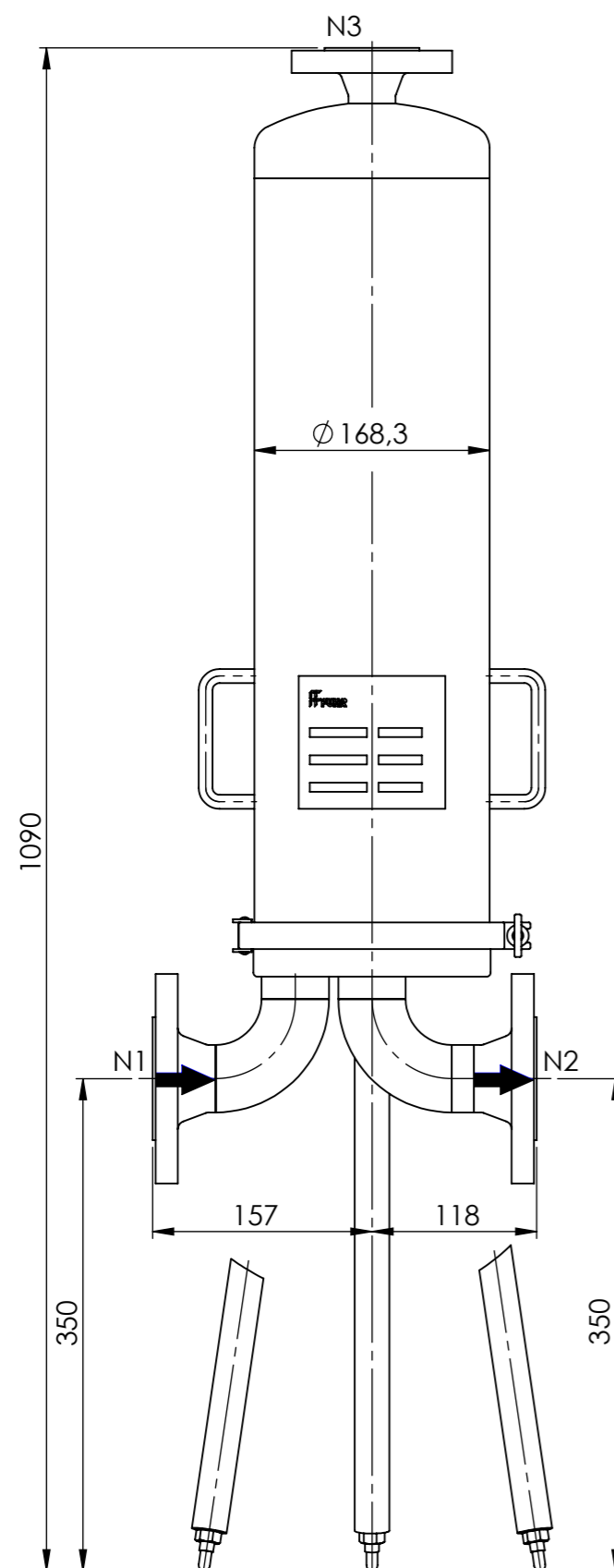

Datum / Date	Name	Benennung / Type
22.05.2015	Neubauer	
		3SFB20-8/F40-A4
		Artikel-Nr. / Article-No.
		1910322405
		Zugehörige Zeichnung / Associated Drawing: A-1219 Rev.0

FUHR GmbH
 Am Weinkastell 14
 55270 Klein-Winternheim