

**DOE FILTER CARTRIDGE
(DOUBLE-OPEN-END)**

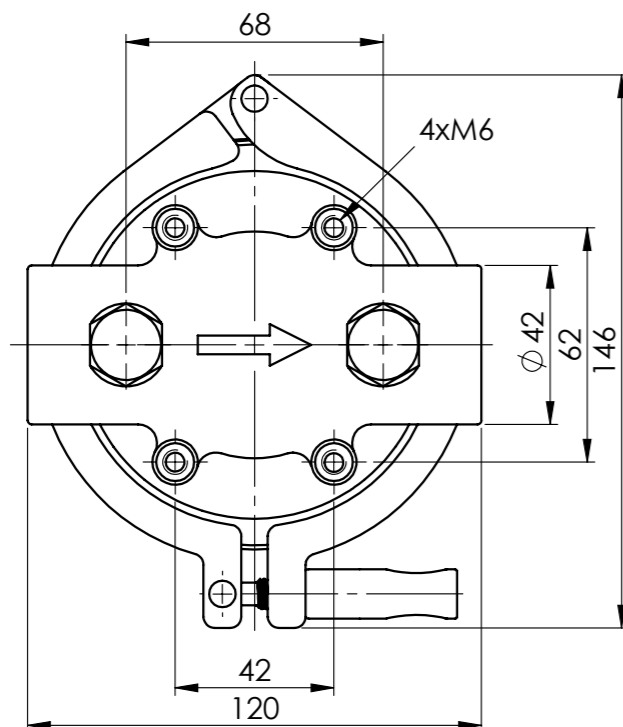

**ADAPTOR FILTER CARTRIDGE
(CODE 8)**

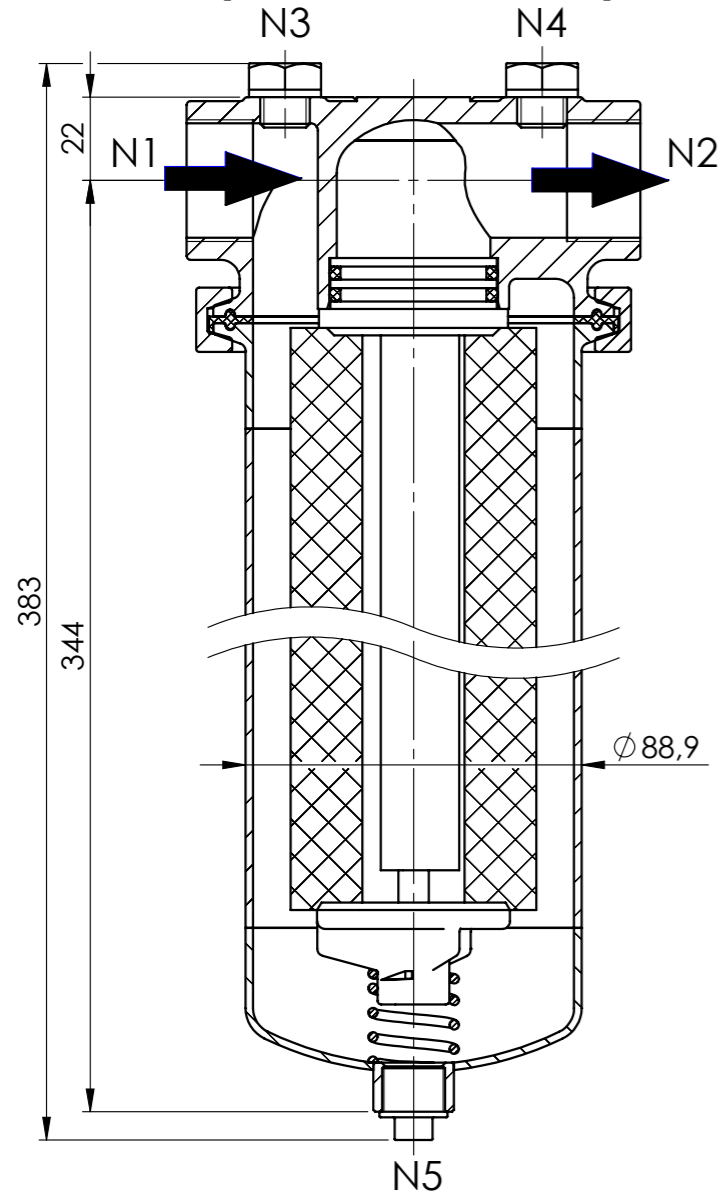
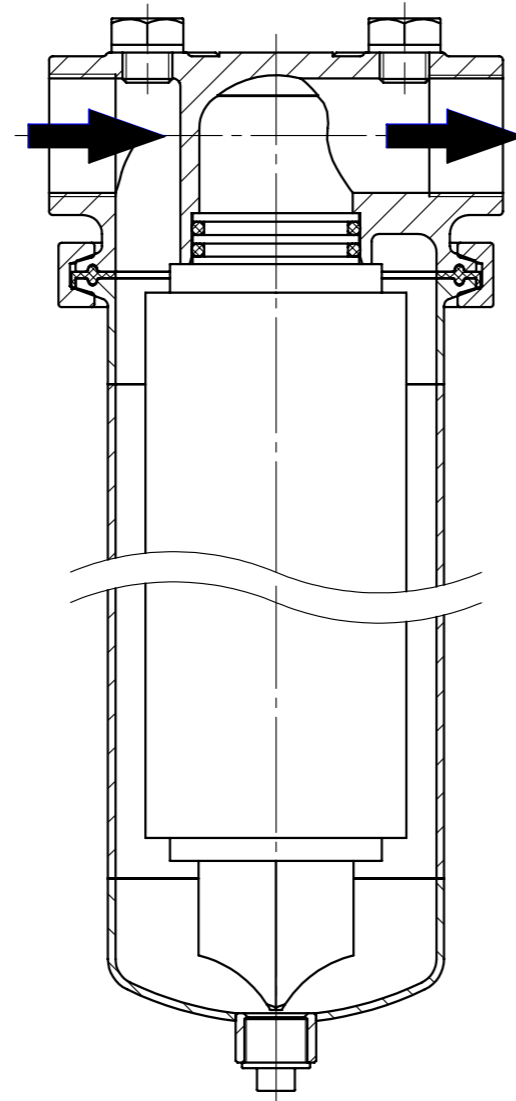

NOZZLE INDEX

Connection	Size	Type	DIN
N1	Rp 1	Inlet	DIN 2999
N2	Rp 1	Outlet	DIN 2999
N3	Rp 1/4	Vent	DIN 2999
N4	Rp 1/4	Vent	DIN 2999
N5	Rp 3/8	Drain	DIN 2986

SPECIFICATION

Max. allow. pressure	25 bar
Max. allow. temperature	-10/+80°C
Volume	2 l
Material Filter Head	AISI 316
Material Filter Sump	AISI 316
Material Insert	AISI 316
Material Quick Closure	AISI 304
Material Gasket	FPM
DOE - Cartridge Length	248 - 254 mm
Adaptor Cartridges	10 inch - CODE 8
Weight	3,7 kg

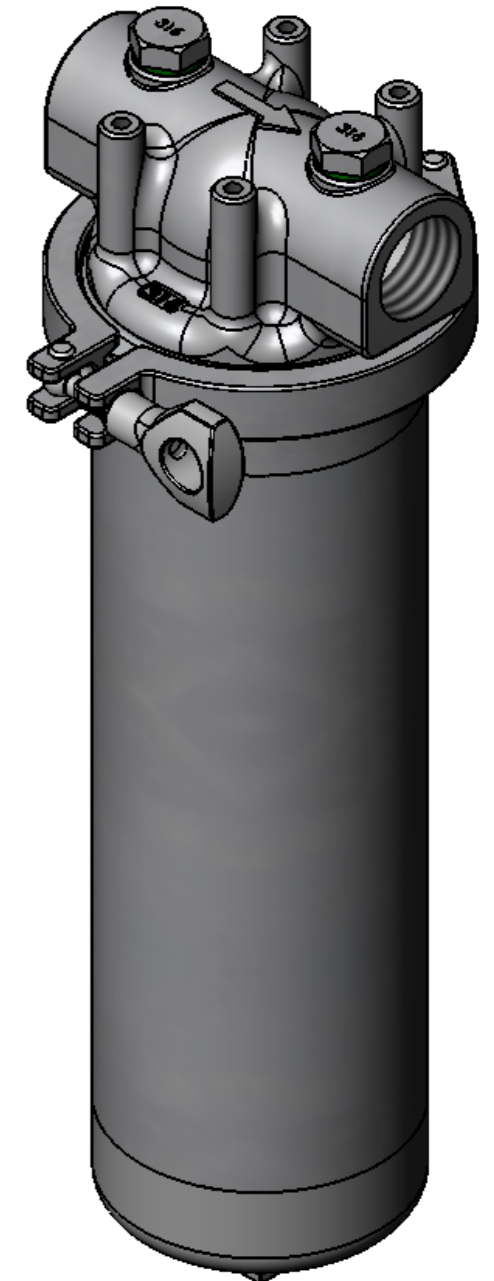

analog fig.

Date	31.07.2014	Name	Leekes	Type	1FUC1-25/25-A4F
Proof.					
Resp.					
Norm				Article-No.	1754412025
 Am Weinkastell 14 55270 Klein-Winternheim				acc. drawing: 10-1392 Rev.0	Repl. for